

WINTERIZATION MODULE

Add on **GEODESIC BLUE® FAMILY TENT**
self-standing

Basic Living Unit for Emergency

Nr. S9999999
Un 27162905

Production date: See bag

ALPINTER

SETUP MANUAL NOTICE DE MONTAGE

تعليمات تركيب

V1.4



Needed to assemble

Nombre de personnes nécessaires pour le montage

ضروري لتركيب

<https://www.alpinter.com/download/>



SETUP INSTRUCTIONS
HERE

2

CONTENT

2.

CONTENU

.2

المحتوى

1 x



A

CENTER TOP CROSSPIECE
CROISILLON CENTRAL DU SOMMET
القطب المركزي العلوي

1 x



G

WINTERIZATION MODULE
MODULE HIVER
نموذج الشتاء

2 x



B

RIDGE POLE
FAITIÈRE
مظلة

10 x

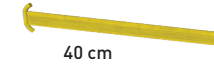

X

T-PEG
PIQUET
وتد

2 x

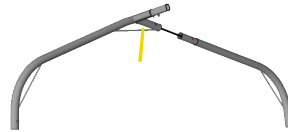

C

DOOR ARCH
ARCHE DE PORTE
قوس الباب

1 x



Y

HAMMER
MARTEAU
مطرقة

4 x



D

DOOR ARCH POLE
PIED D'ARCHE DE PORTE
قوس الباب

1 x



E

CENTRAL POLE
MAT CENTRAL
القطب المركزي

2 x



F

REMOVABLE DOOR POLE
PIED DE PORTE ESCAMOTABLE
باب قابل للإزالة

3

SETUP INSTRUCTIONS

3.

INSTRUCTIONS DE MONTAGE

.3

تعليمات التركيب



01

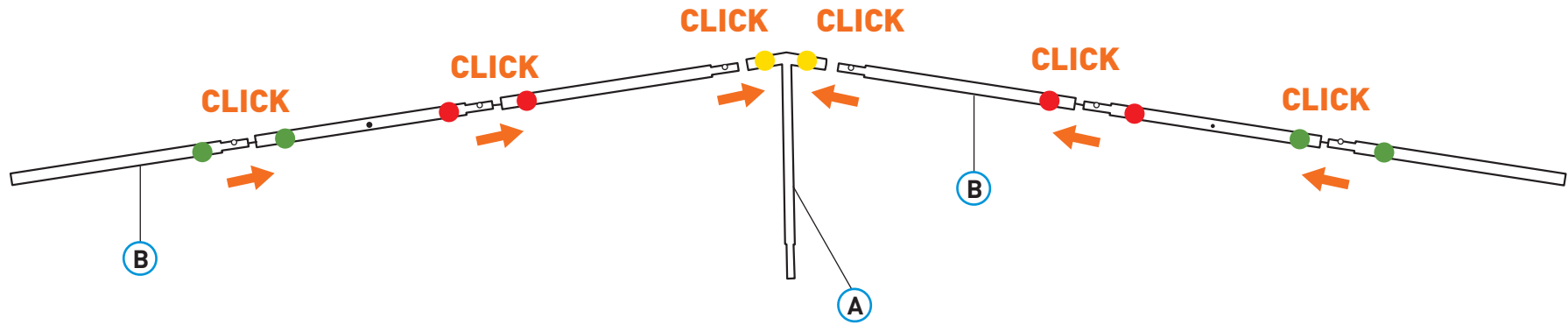

02

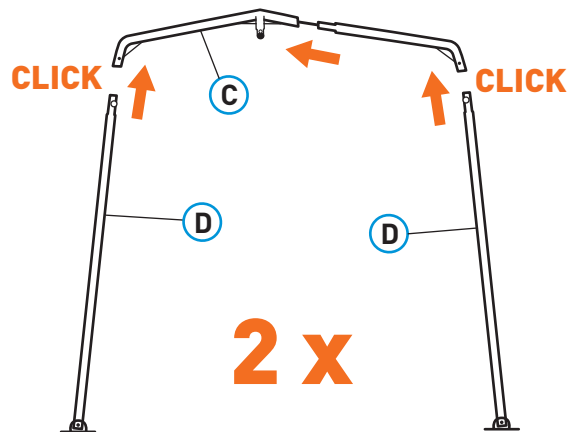

03

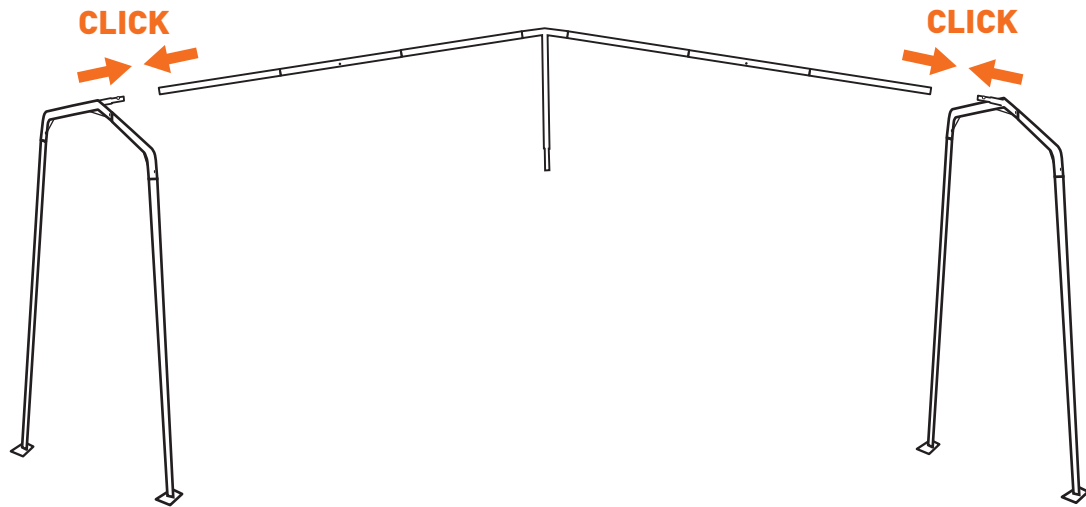

04

If the tent is already set up, remove shade cover and store for later use



05

1x

E

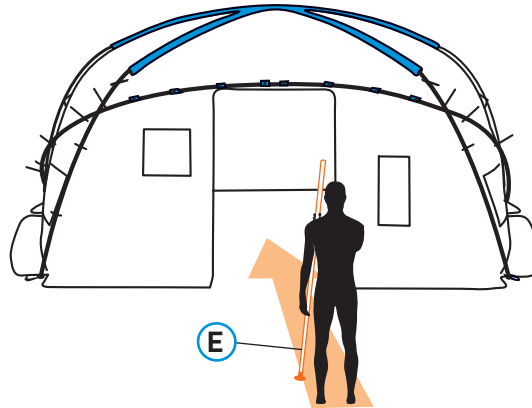

06

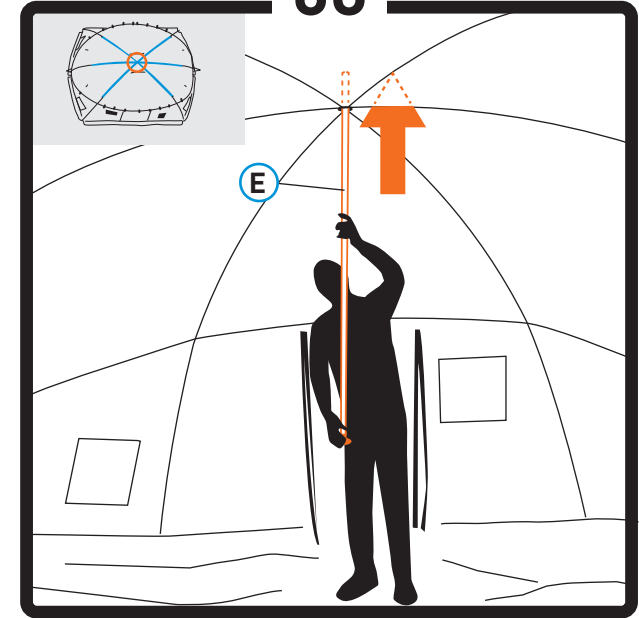

07

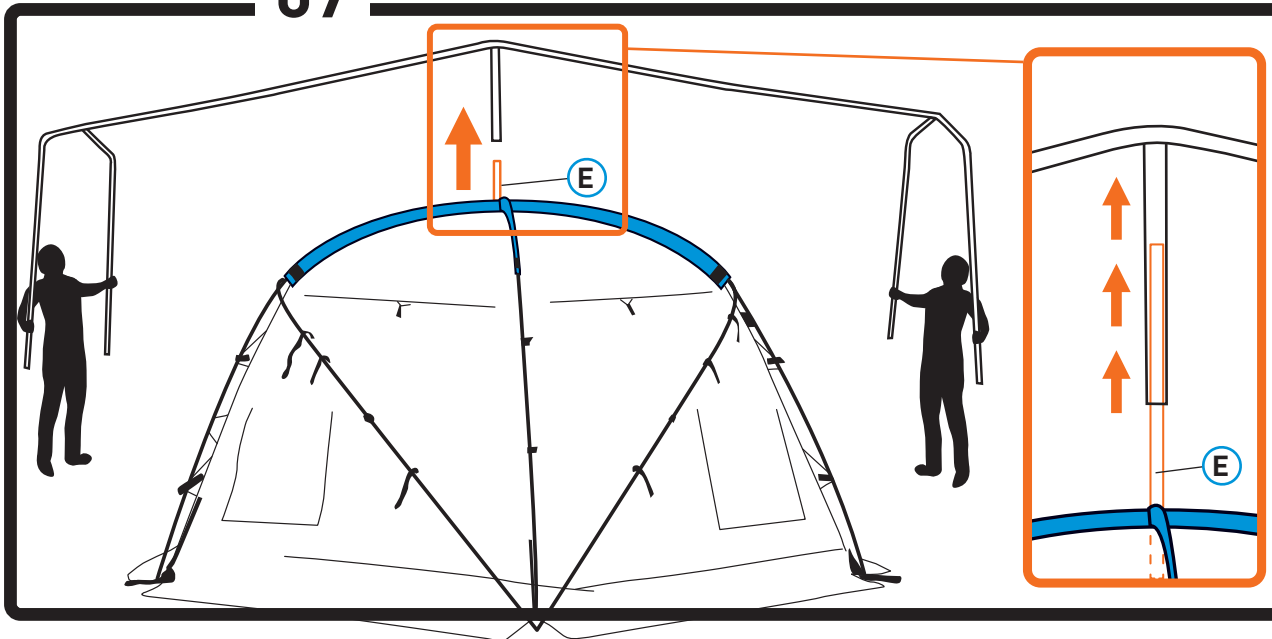

08

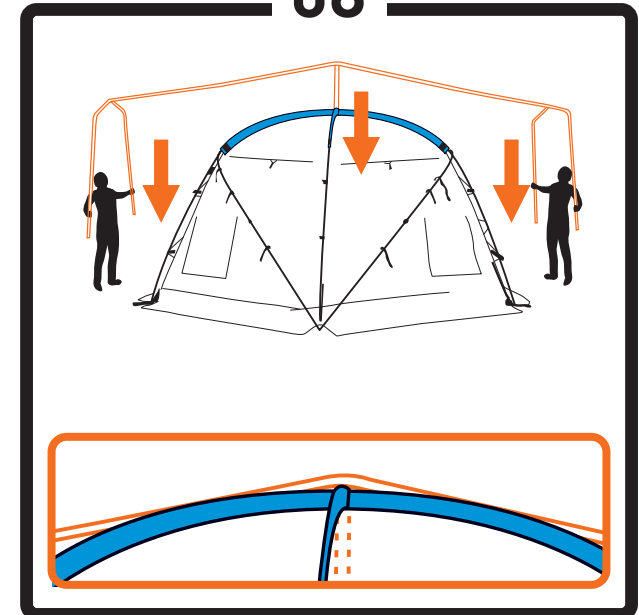

09

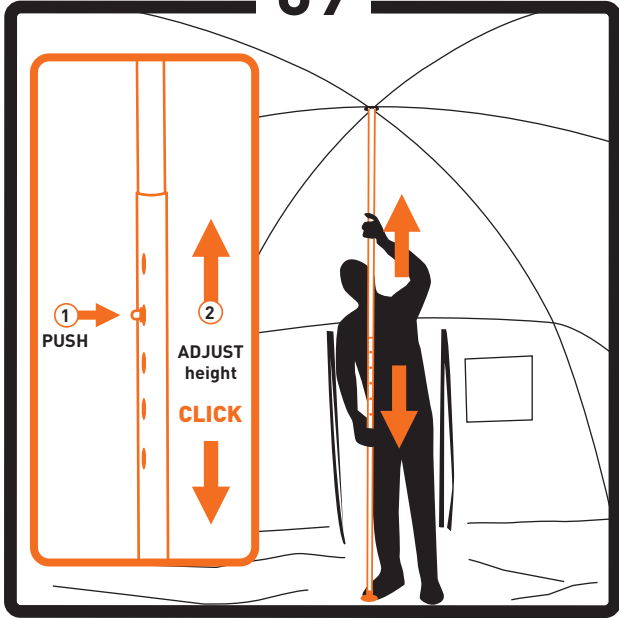

10

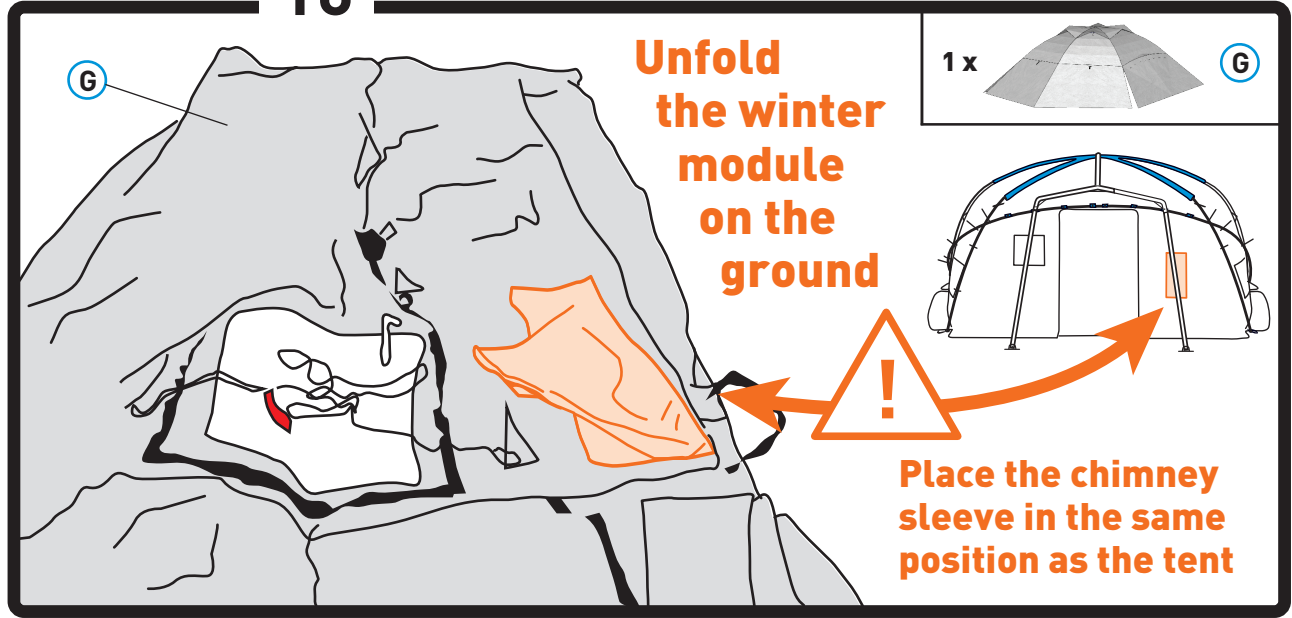

11



12

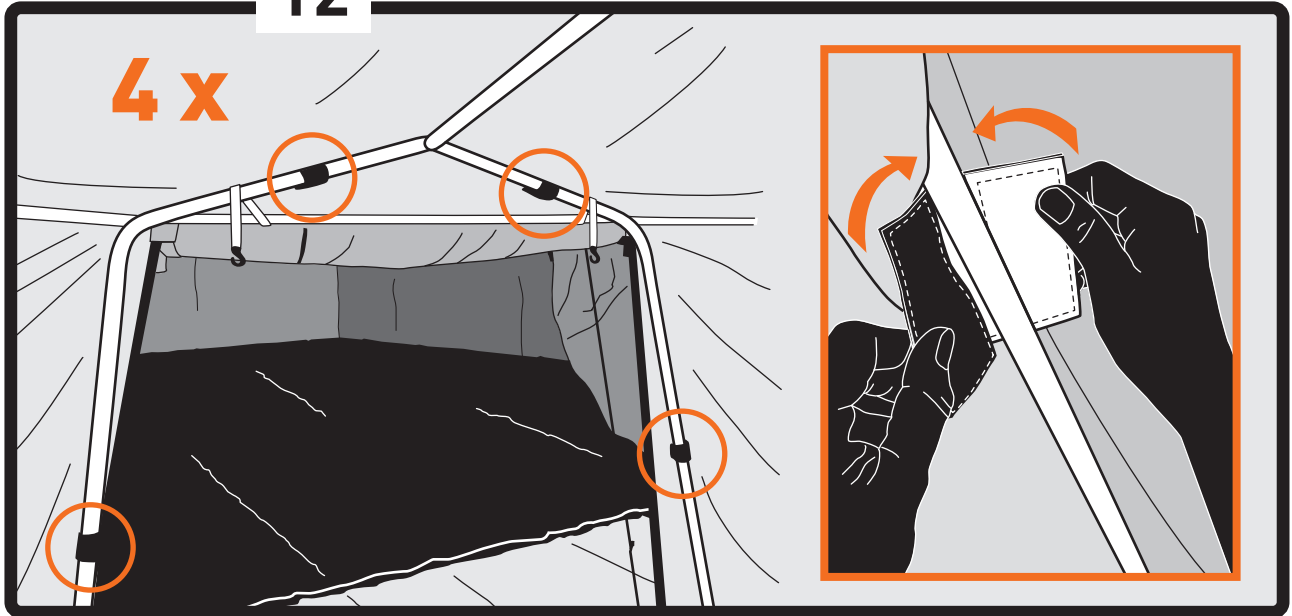

13

Pull the winter module gradually over the frame

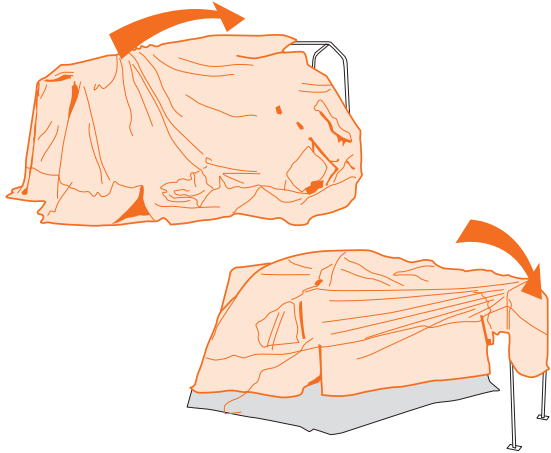

14

second vestibule

4 x

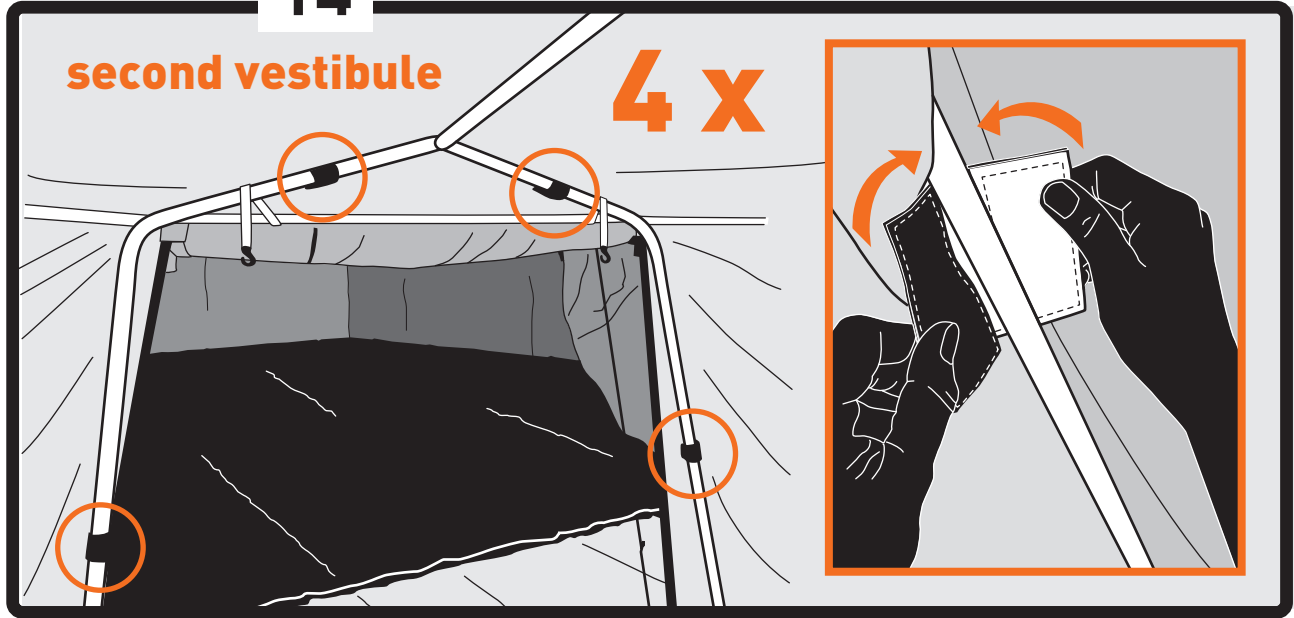

15

Attach all the velcro straps

12 x

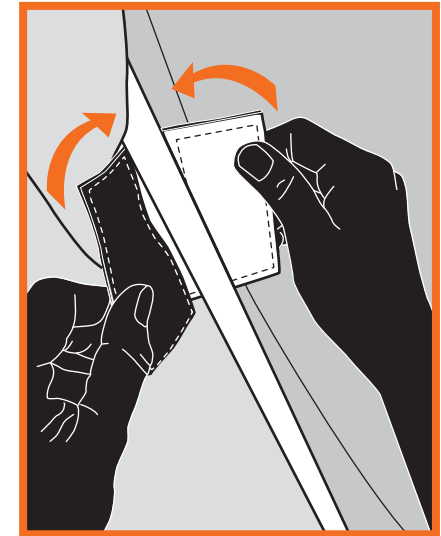
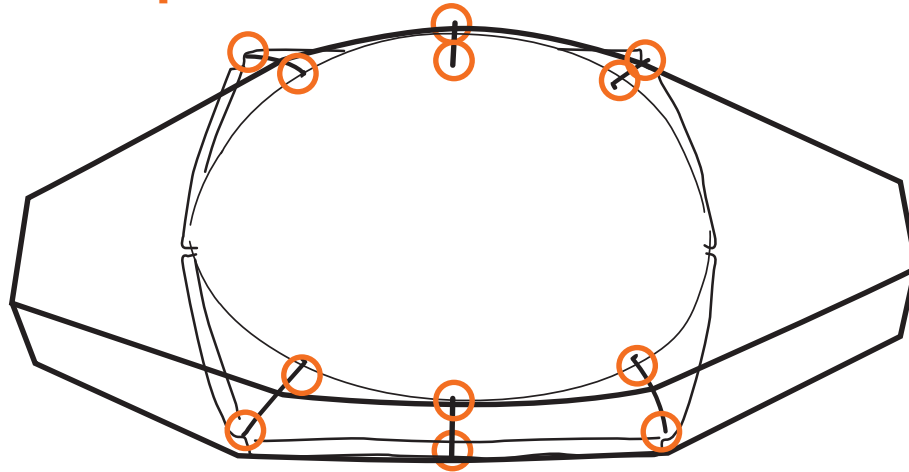

16

4 x



1



2

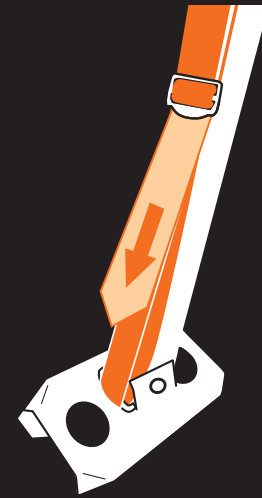

3

Attach the mudflap webbing onto the foot plates

17

6 x



1



2

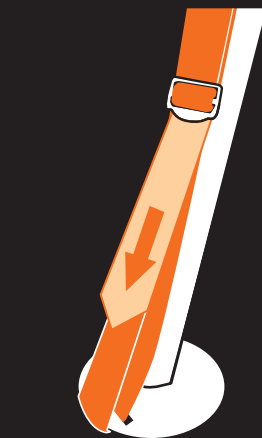

3

18

2 x

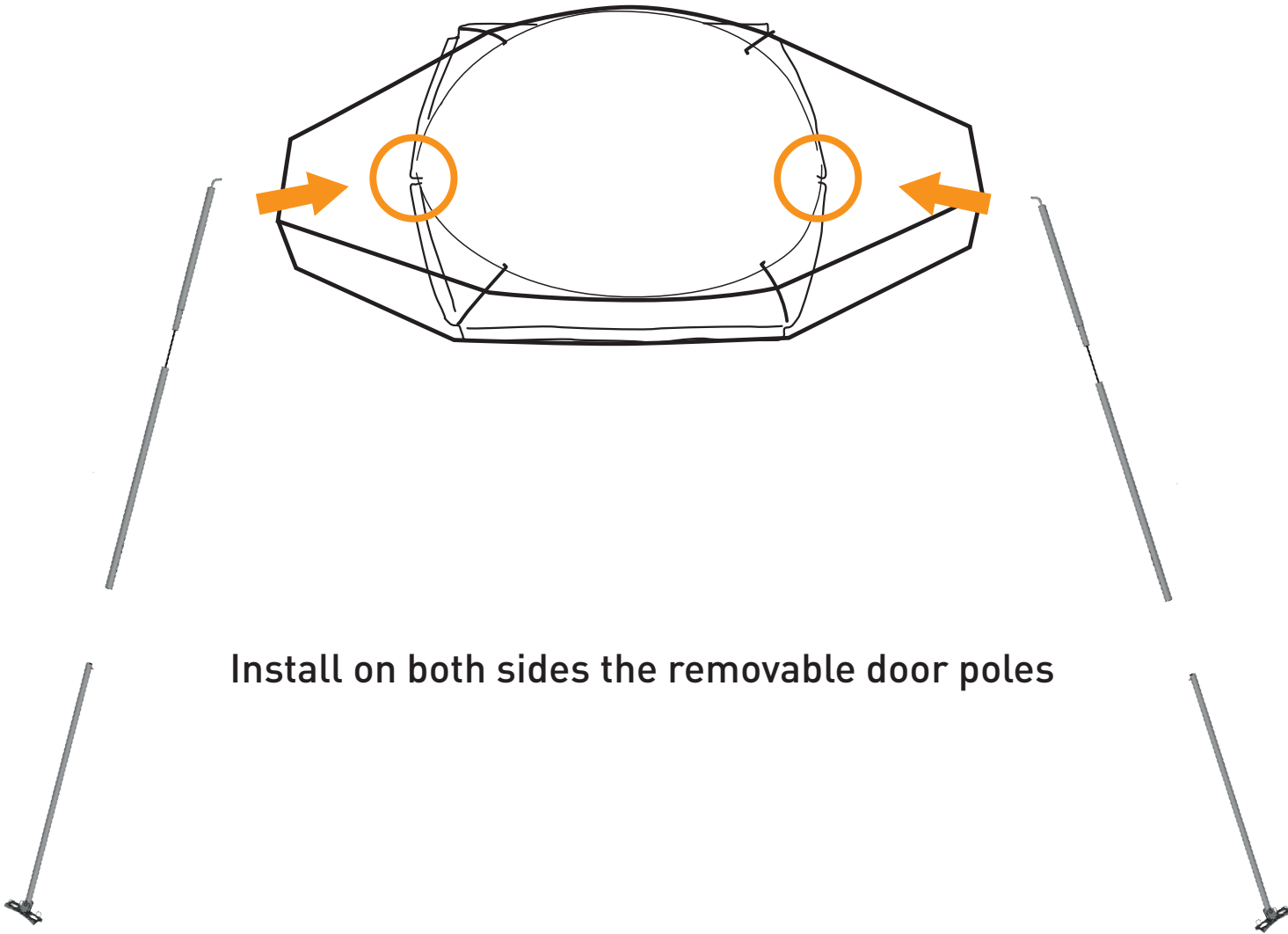

Install on both sides the removable door poles

19

10 x



1 x

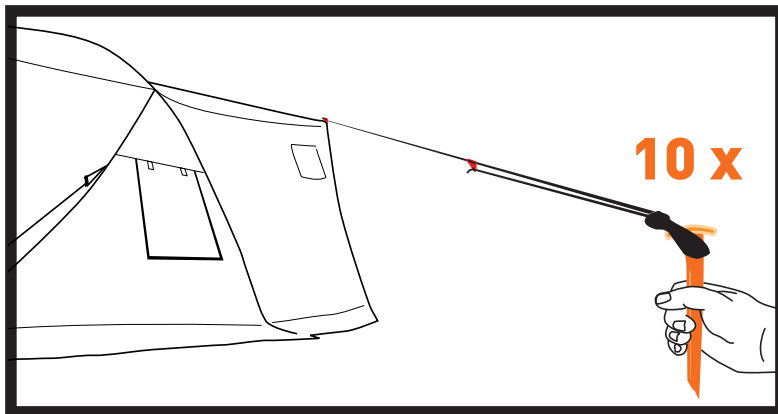
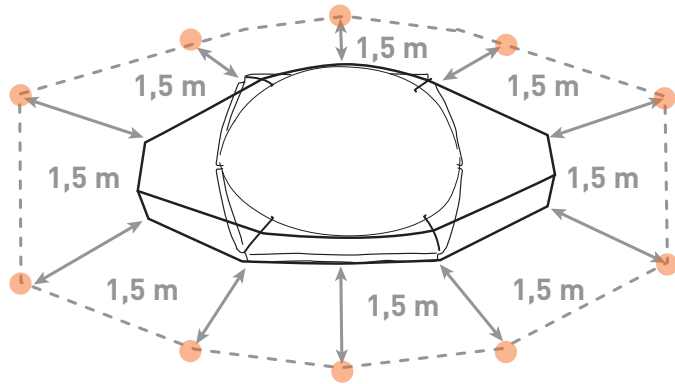

1

Pegs should always point towards the tent

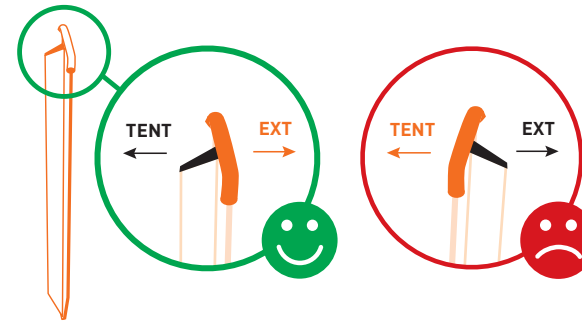

2

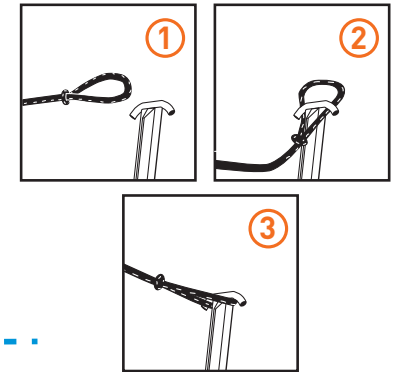
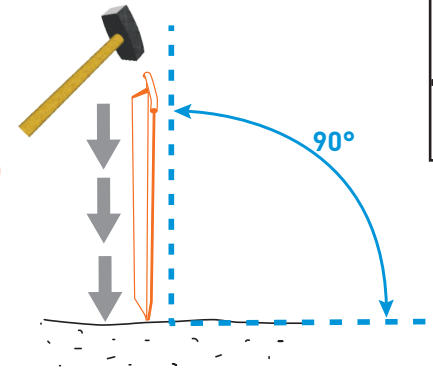

3

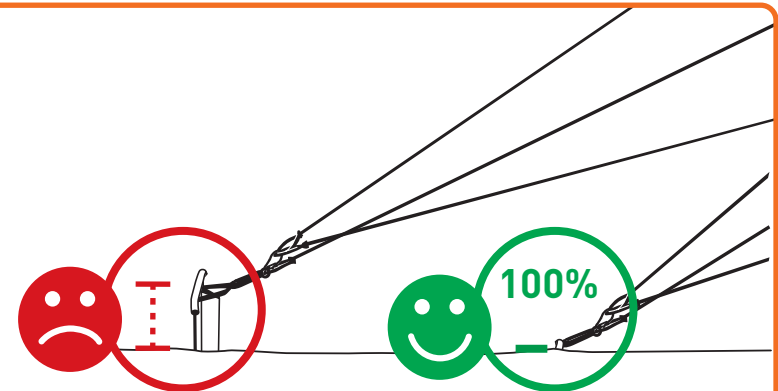

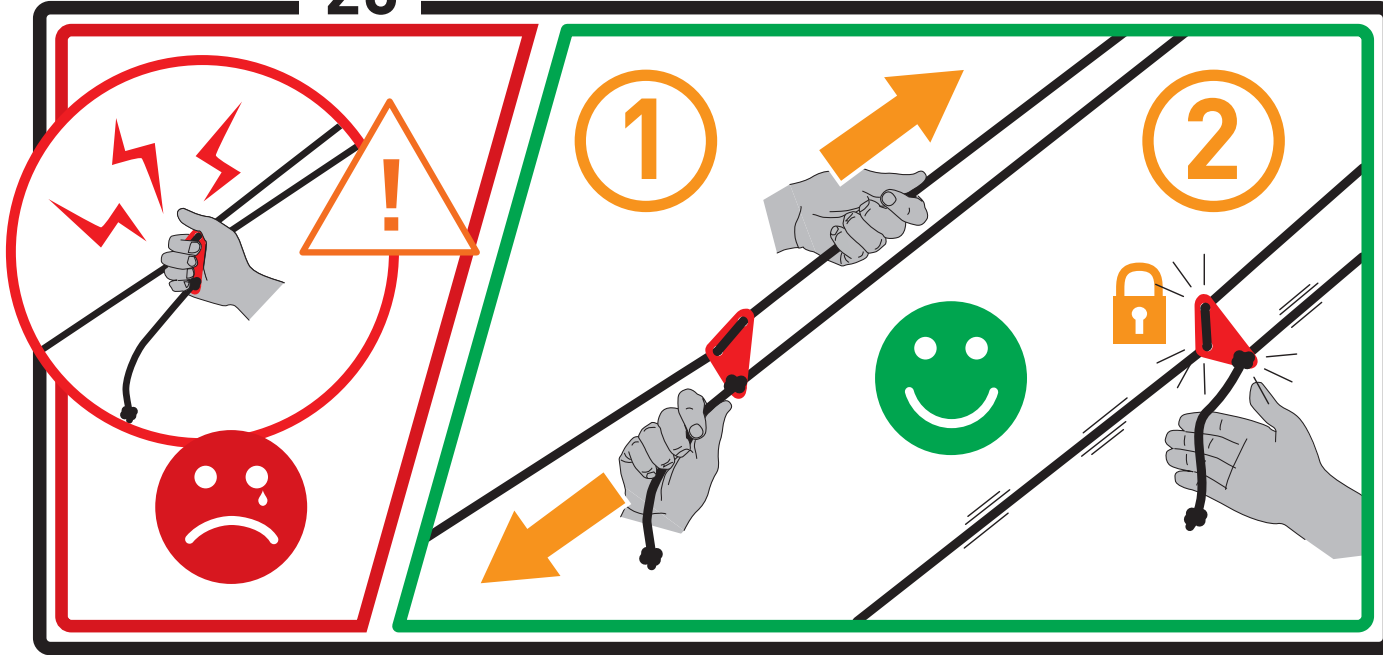

If necessary, use the 6 pegs delivered with the tent to reinforce the winter module guypoints

END

12.

CONTACT

ALPINTER

HEAD OFFICE

ALPINTER BELGIUM

CHARLES DE GAULLESTR. 7

B-9600 RENAIX - RONSE | BELGIUM | **EUROPE**

Tel: +32 (0)55 23 17 54

REGIONAL OFFICES

ALPINTER BULGARIA

35-37 KLOKOTNITZA ST | AP.1

1233 | SOFIA

BULGARIA

WORLD OF TENTS MIDDLE EAST FZ-LLC

PLOT 17 | AL HAMRA INDUSTRIAL ZONE-FZ | RAKEZ

RAS AL KHAIMAH | U.A.E. | **MIDDLE EAST**