

SHADE COVER 42 m²

Add on **HUB** tent 42 m²

UN27162561

Production date: See box

ALPINTER 

SETUP INSTRUCTIONS

V1.0



PACKING LIST

PACKED IN ONE BAG - 210 x 50 x 25 cm - 60 kg

Ⓐ 10 x POLE CONNECTOR



Ⓓ 10 x STANDING POLE



Ⓑ 6 x FRAME END POLE

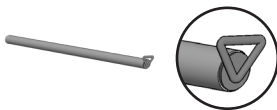

Ⓔ 1 x SHADE COVER

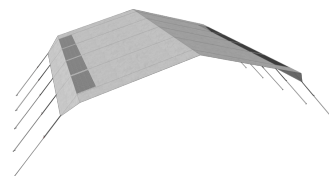

Ⓒ 8 x RIDGE POLE

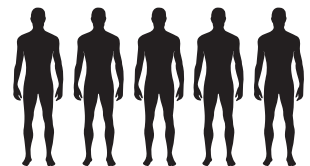

Needed to assemble
this SHADE COVER



2x  **1**

Insert part **B** in end ridge pipe **2x**

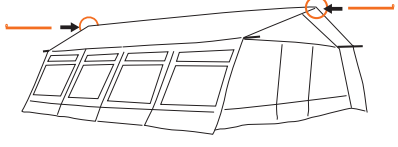

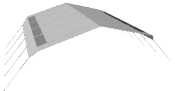
1x  **2**

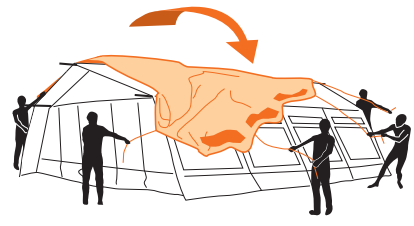

3

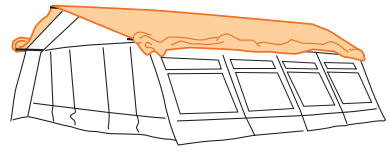

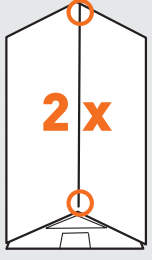
2x 

1

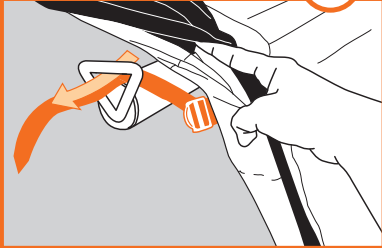



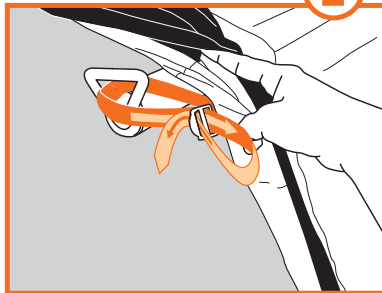

2

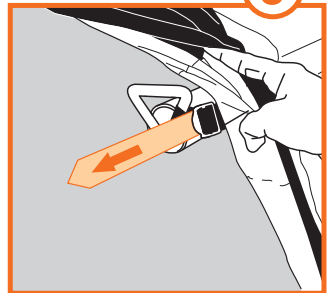

3



4

5x  2x  4x  5x  **5**

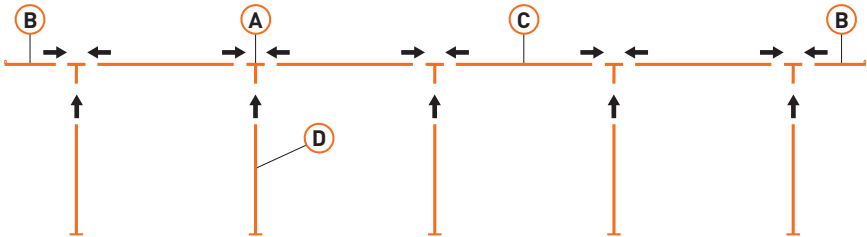

6

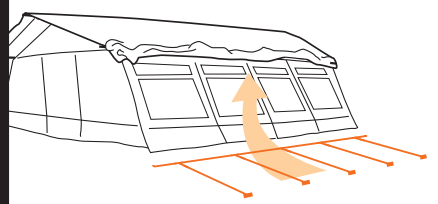

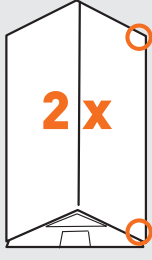
2x 

1



2

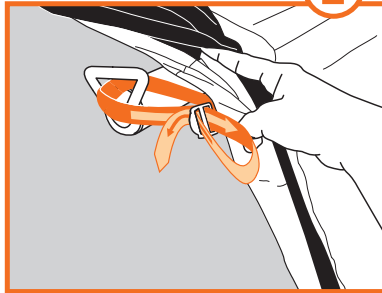

3

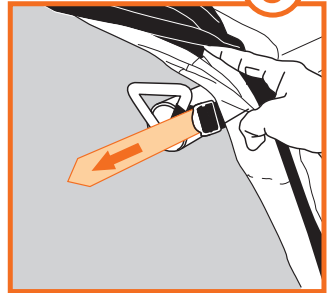

7



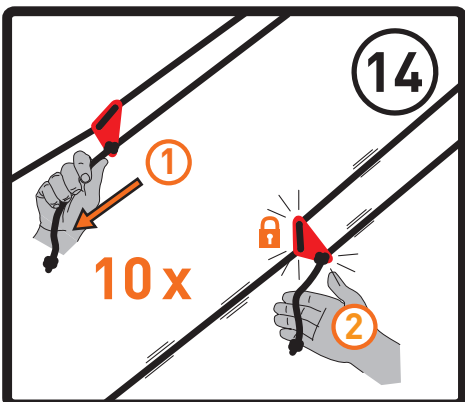
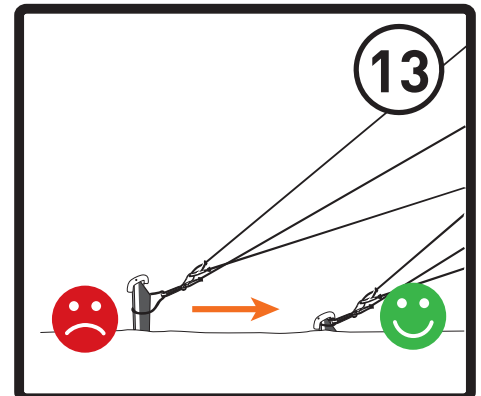
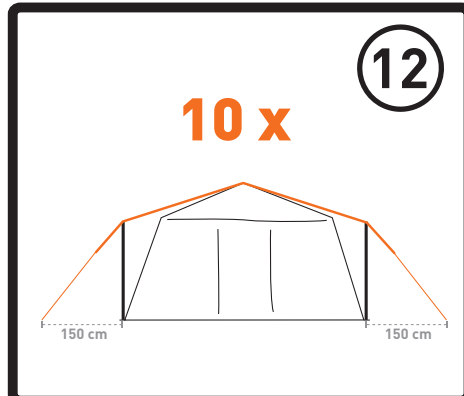
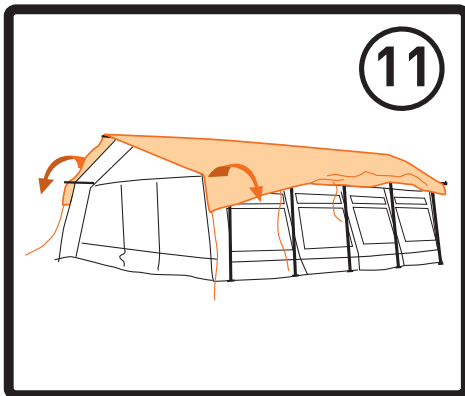
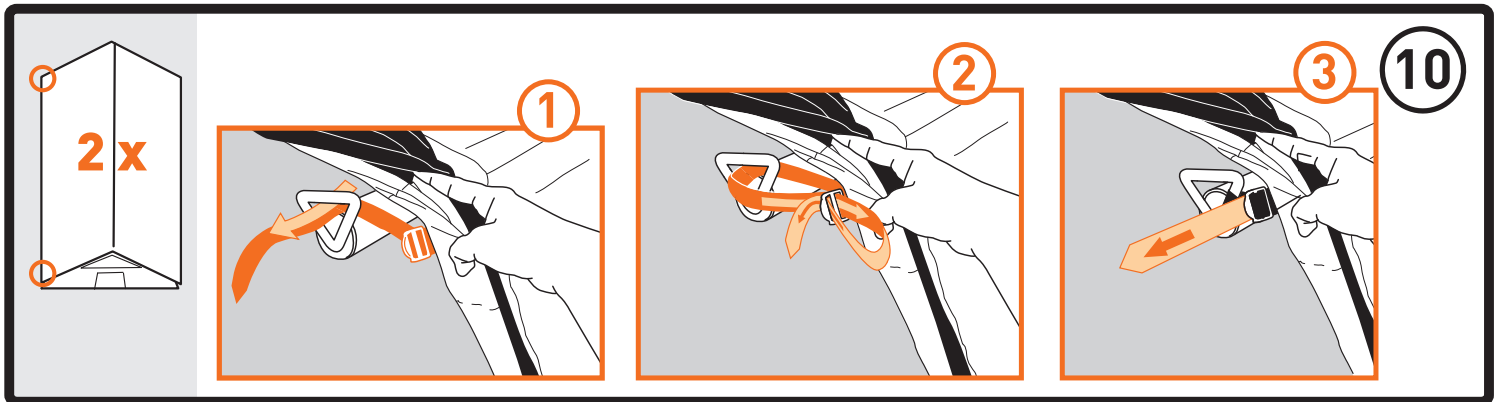
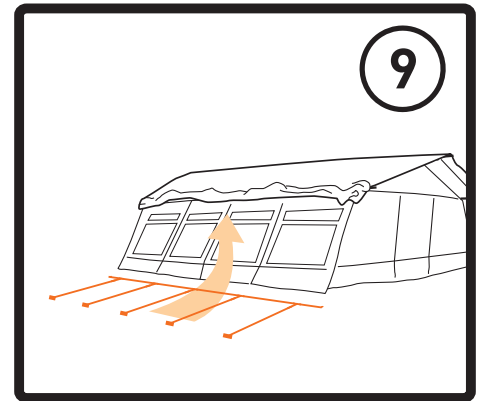
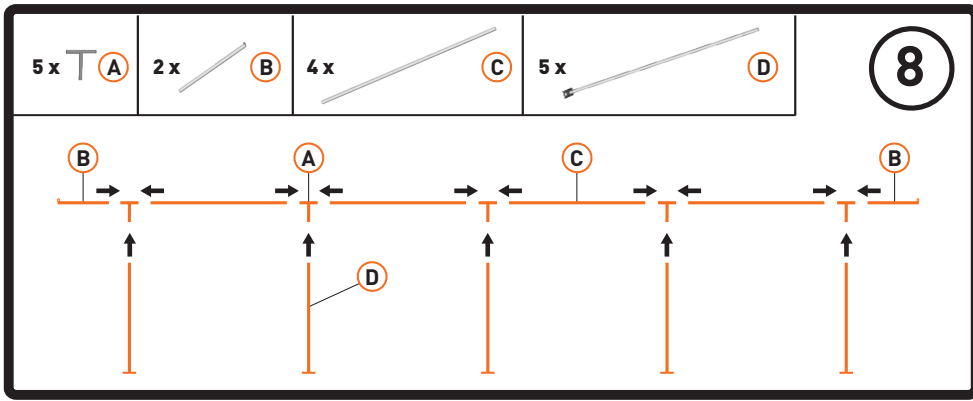

END