

WINTERIZATION MODULE

Add on **GEODESIC BLUE® FAMILY TENT**
self-standing

Basic Living Unit for Emergency

Nr. S9999999
Un 27162905

Production date: See bag

ALPINTER 

SETUP MANUAL NOTICE DE MONTAGE

تعليمات تركيب

V1.2

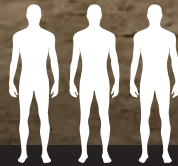

Needed to assemble

Nombre de personnes nécessaires pour le montage

ضروري لتركيب

<https://www.alpinter.com/download/>



2

CONTENT

2.

CONTENU

.2

المحتوى

1 x



A

CENTER TOP CROSSPIECE
CROISILLON CENTRAL DU SOMMET
القطب المركزي العلوي

1 x



G

WINTERIZATION MODULE
MODULE HIVER
نموذج الشتاء

2 x



B

RIDGE POLE
FAITIÈRE
مظلة

10 x



X

T-PEG
PIQUET
وتد

2 x



C

DOOR ARCH
ARCHE DE PORTE
قوس الباب

1 x



Y

HAMMER
MARTEAU
مطرقة

4 x



D

DOOR ARCH POLE
PIED D'ARCHE DE PORTE
قطب قوس الباب

1 x



E

CENTRAL POLE
MAT CENTRAL
القطب المركزي

2 x



F

REMOVABLE DOOR POLE
PIED DE PORTE ESCAMOTABLE
باب قابل للإزالة

3

SETUP INSTRUCTIONS

3.

INSTRUCTIONS DE MONTAGE

.3

تعليمات التركيب



01

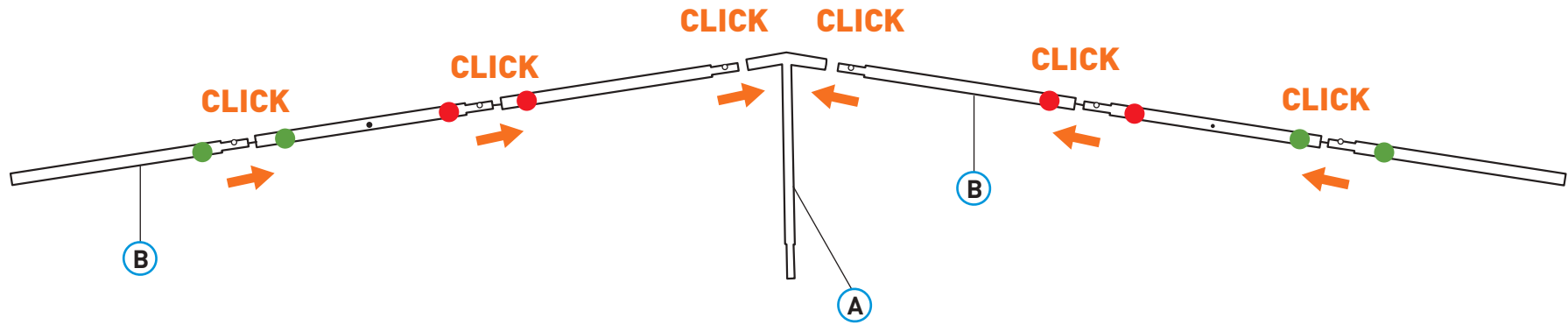

02

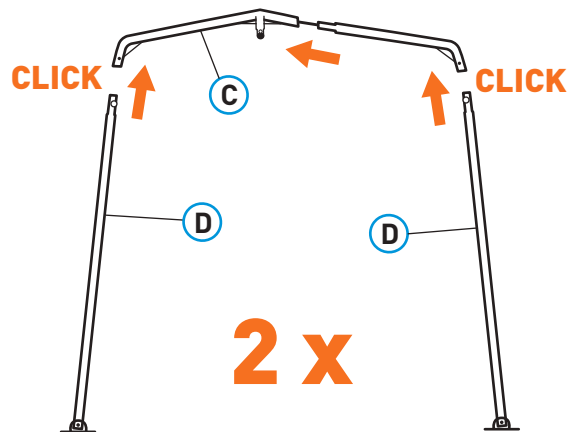

03

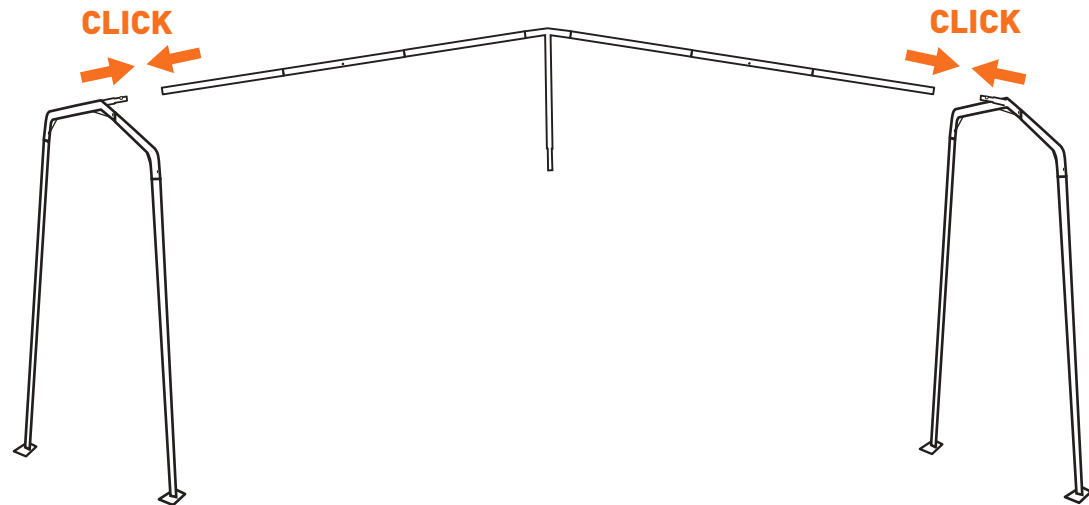

04

If the tent is already set up, remove shade cover and store for later use



05

1x (E)

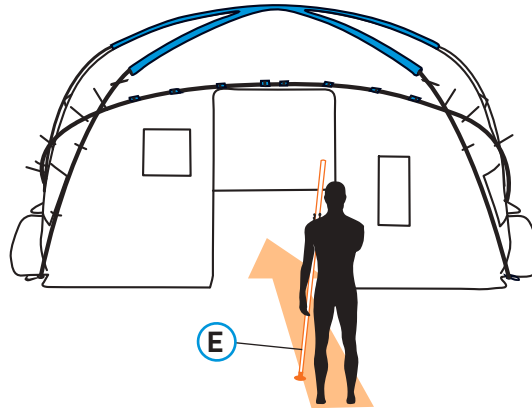

06

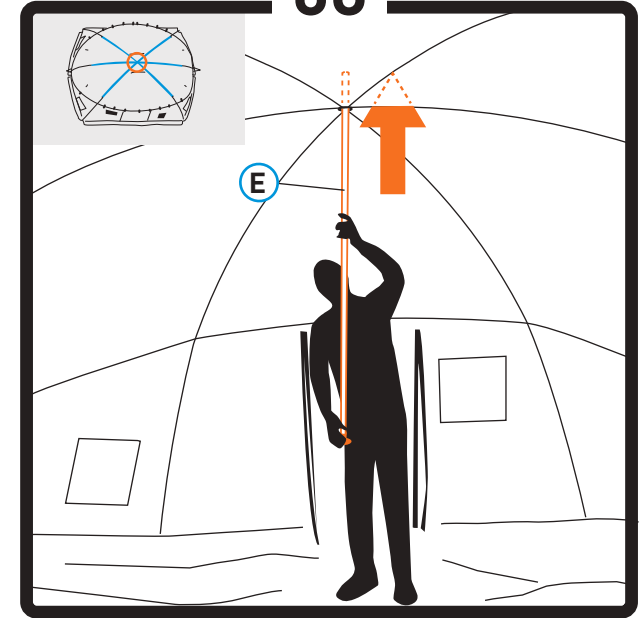

07

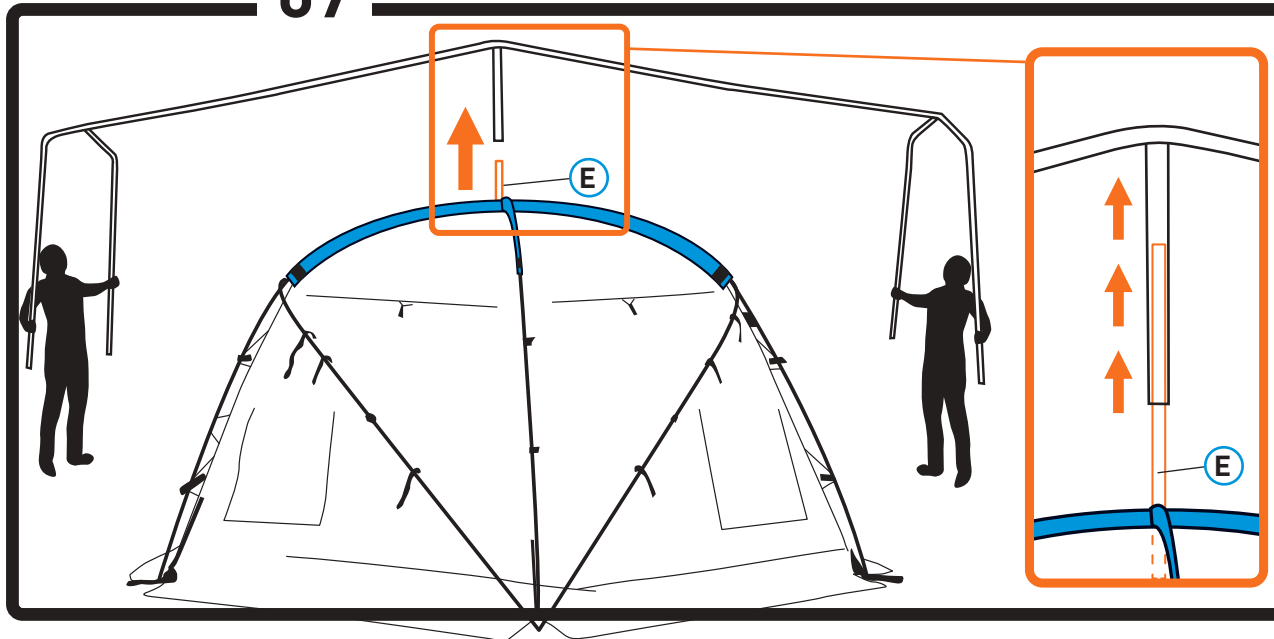

08

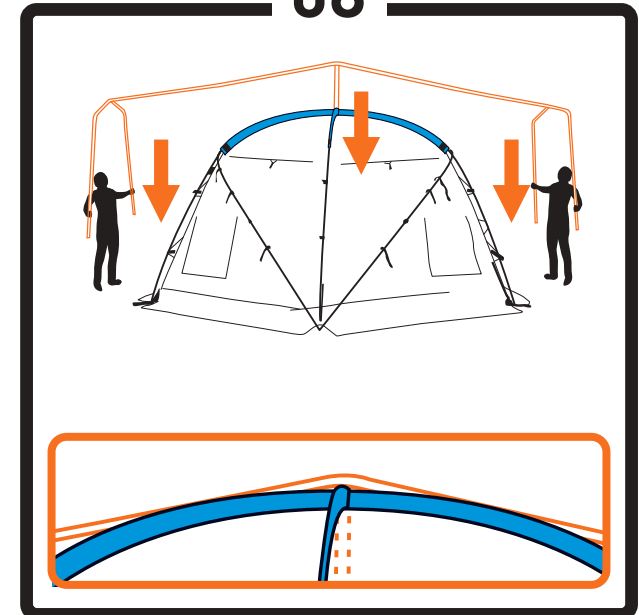

09

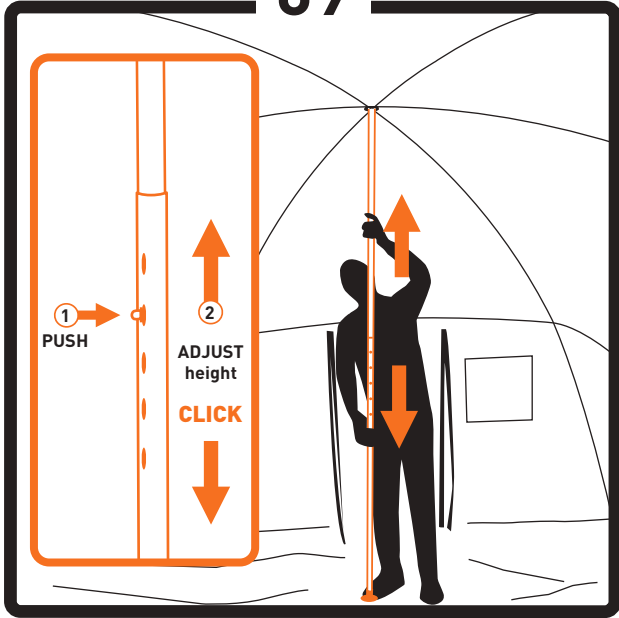

10

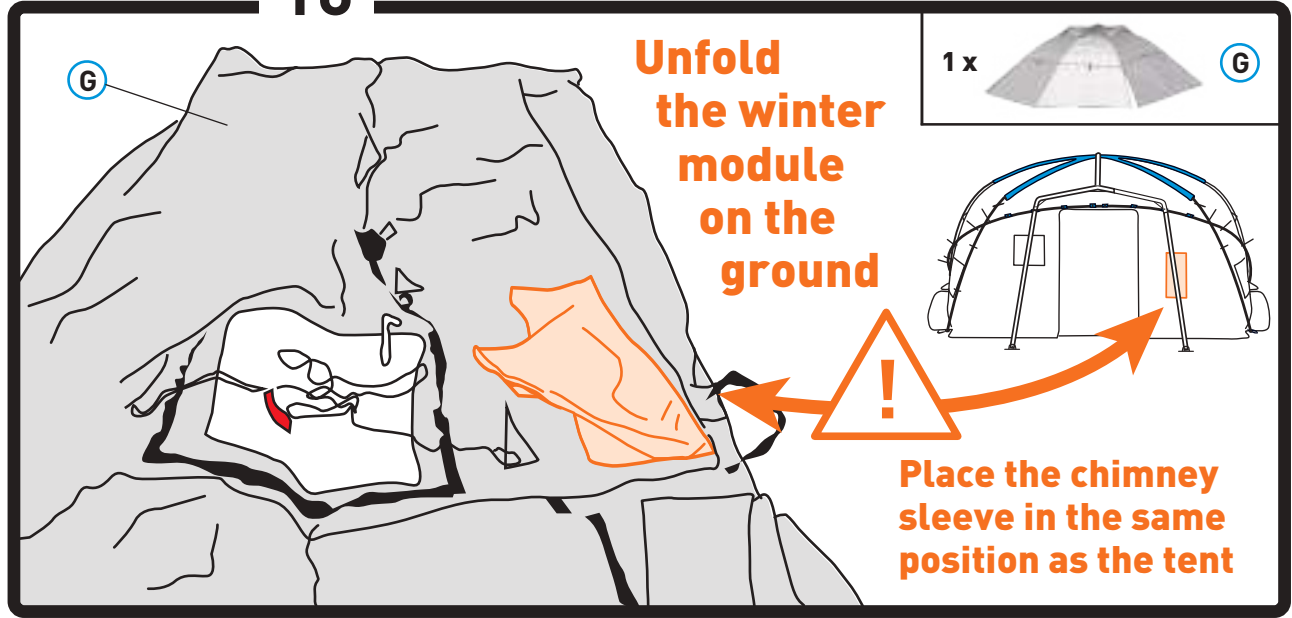

11



12

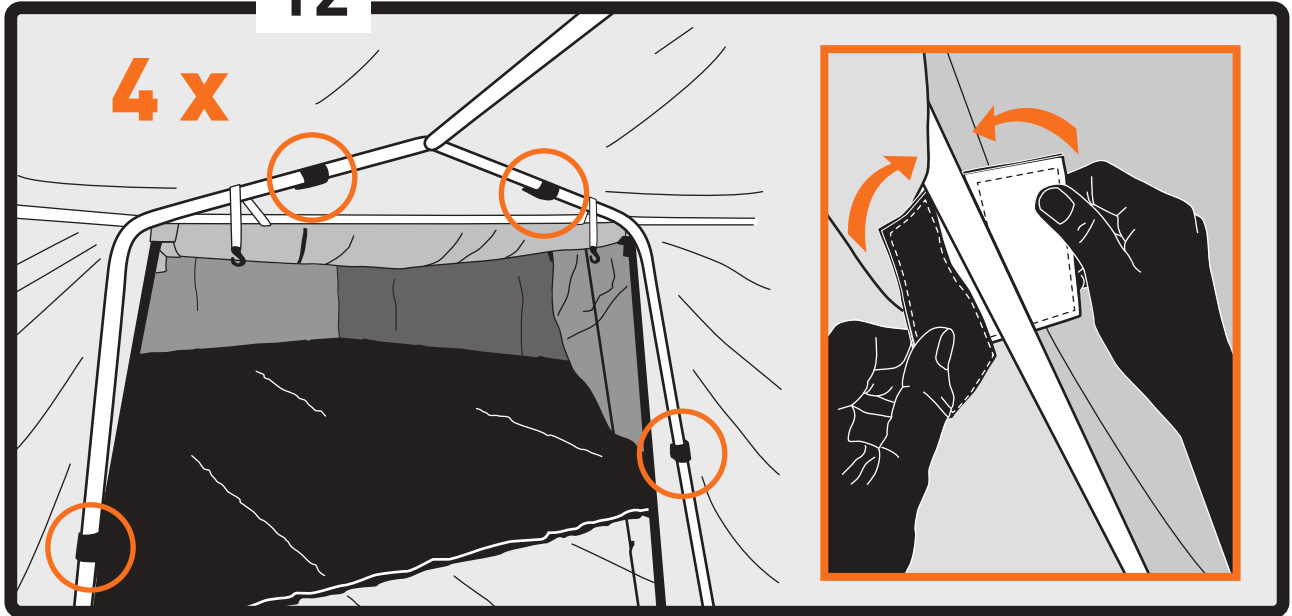

13

Pull the winter module gradually over the frame

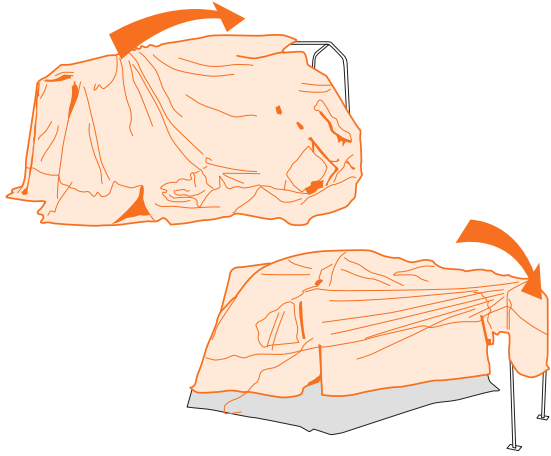

14

second vestibule

4 x

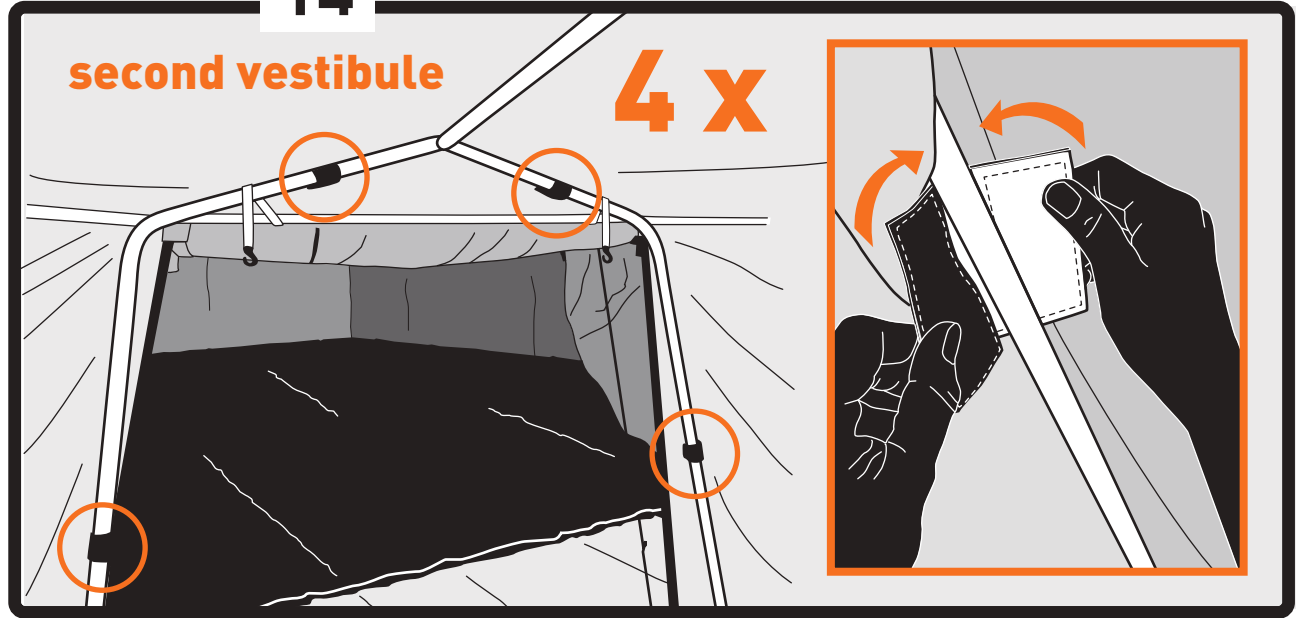

15

Attach all the velcro straps

12 x

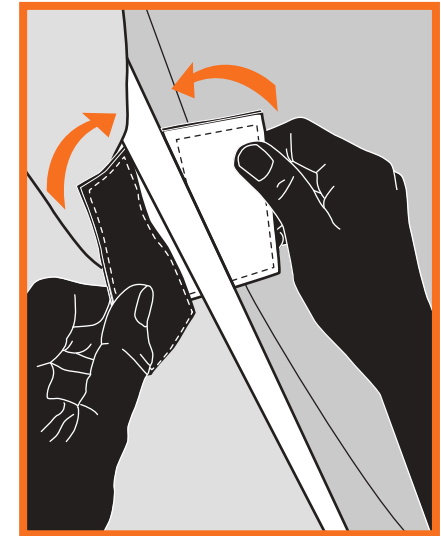
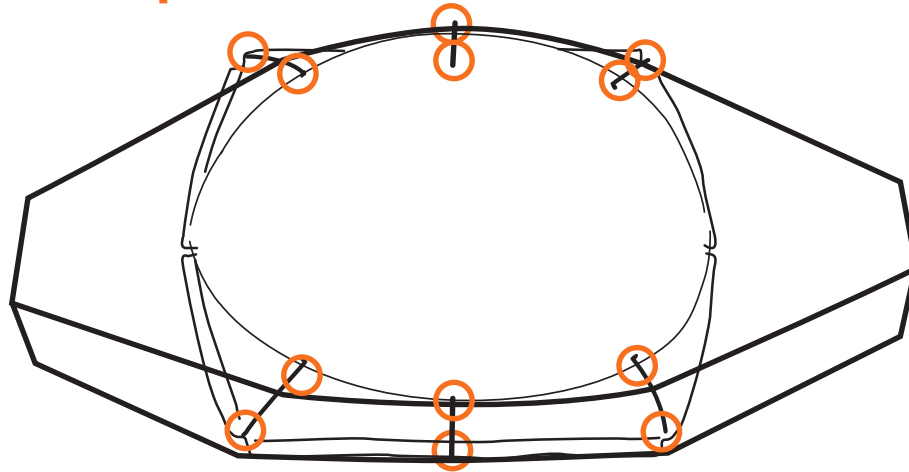

16

4 x



1



2

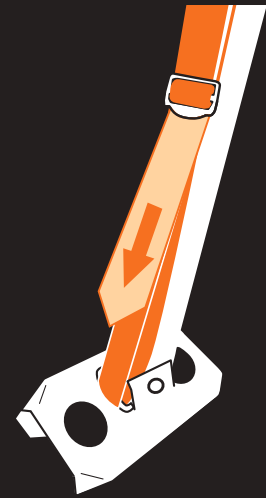

3

Attach the mudflap webbing onto the foot plates

17

6 x



1



2

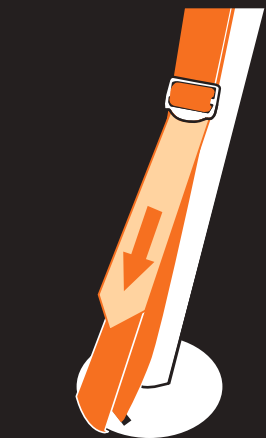

3

18

10 x



1 x

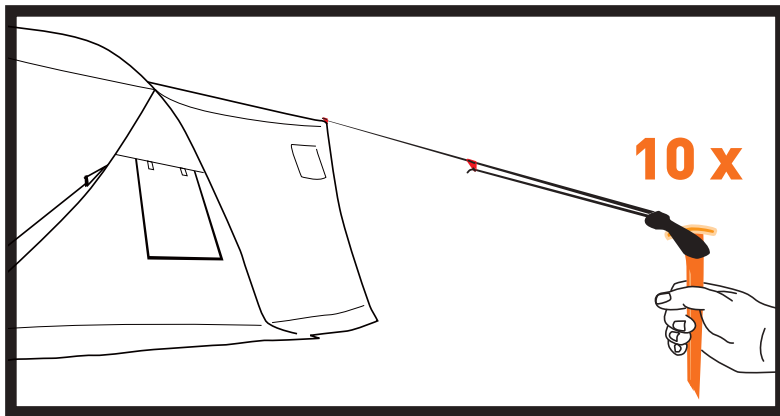
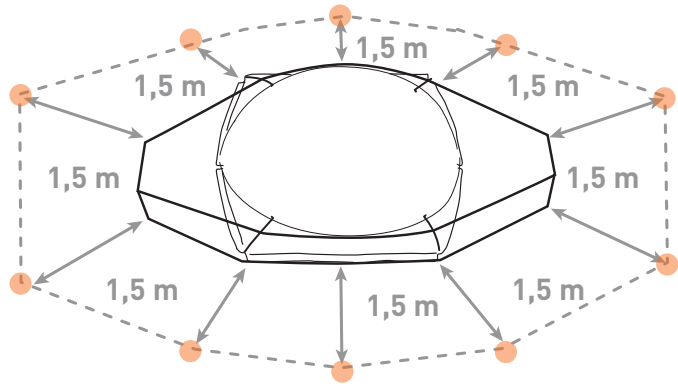

1

Pegs should always point towards the tent

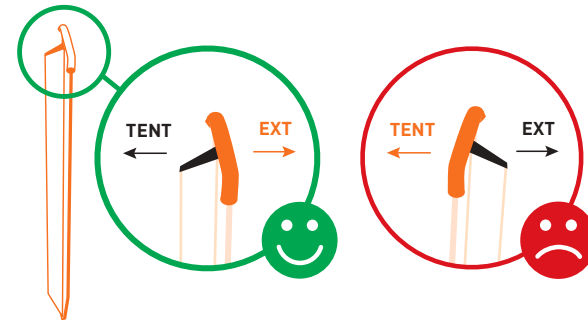

2

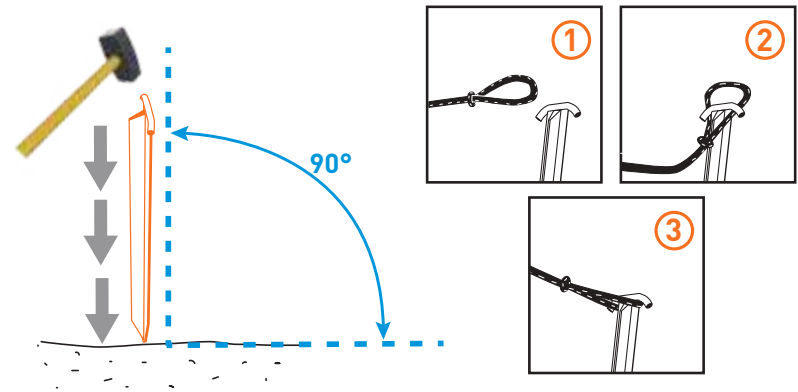

3

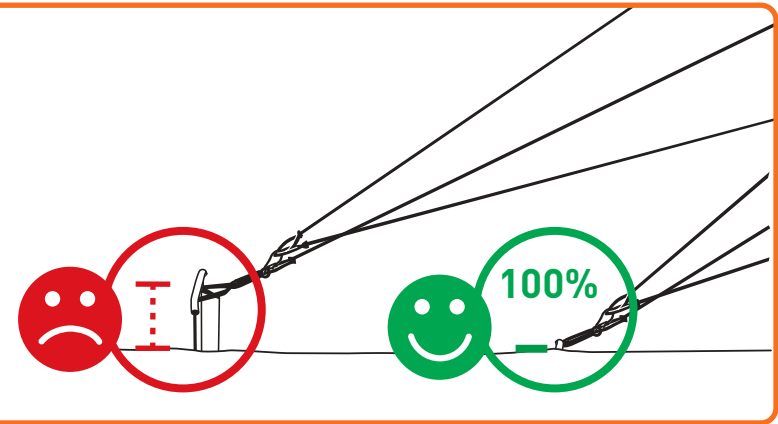

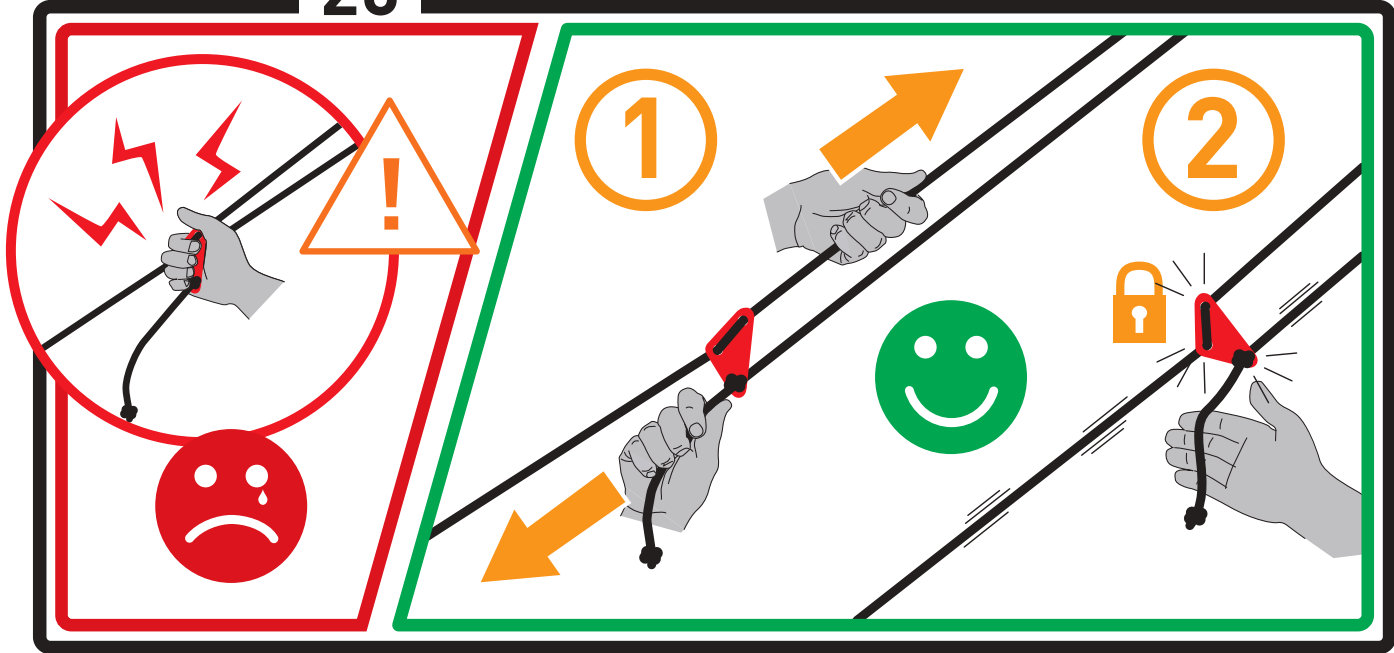

END

If necessary, use the 6 pegs delivered with the tent to reinforce the winter module guypoints

12.

CONTACT



HEAD OFFICE

ALPINTER BELGIUM

CHARLES DE GAULLESTR. 7
B-9600 RENAIX - RONSE | BELGIUM | **EUROPE**
Tel: +32 (0)55 23 17 54

REGIONAL OFFICES

ALPINTER BULGARIA

35-37 KLOKOTNITZA ST | AP.1
1233 | SOFIA
BULGARIA

ALPINTER DUBAI

INTERNATIONAL HUMANITARIAN CITY
BUILDING N° 1 | SECOND FLOOR | OFFICE 207
DUBAI INDUSTRIAL CITY | PO BOX 506047
DUBAI | U.A.E. | **MIDDLE EAST**

ALPINTER UGANDA

PLOT 224-226, KYEYUNE ROAD | KIGGUNDU ZONE
KANSANGA | PO BOX 25525
KAMPALA | UGANDA | **EAST AFRICA**

ALPINTER ASIA

ALPINTER ASIA LTD.
RM 1902, HUA FU COMMERCIAL BLD.
111 QUEENS ROAD WEST
SHEUNG WAN | HONG KONG | **ASIA**

PRODUCTION SITE & PARTNER



info@alpinter.com | www.alpinter.com